

16



373en16

ORGANIZATION OF TOURNAMENT



Note

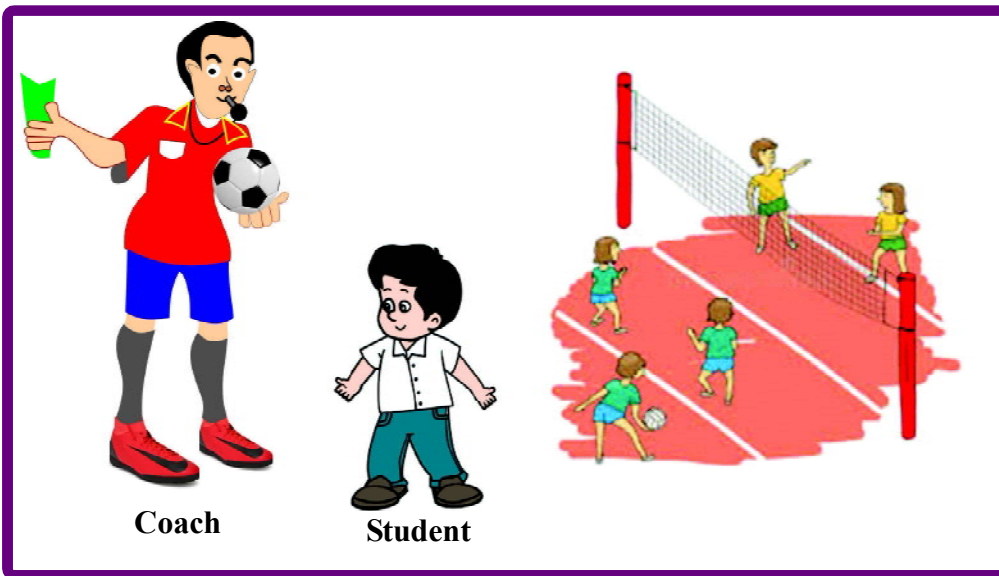

Coach

Student

Read the conversation between student and coach.

**Student :** Good Morning Coach.

**Coach :** Good Morning Vikas.

**Student :** Sir, are we organizing some tournament?

**Coach :** Yes, Vikas we are Organizing a volleyball tournament.

**Student :** Can you tell me, what is a Tournament?

**Coach :** Yes, of course. A Tournament is a series of games or matches that are used to decide the winner of a competition.

**Student :** Oh!

**Coach :** In sports a tournament is often used at the conclusion of the season to crown the league’s champion.

**Student :** Thank you Coach.

Dear learner, in this lesson you will learn about meaning, definition and importance of tournament, types of tournaments, and how tournaments are conducted.



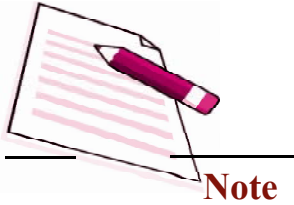

**OBJECTIVES**

After studying this chapter you will be able to:

- explain the meaning, definition and importance of Tournament;
- describe the different types of tournament and draw fixtures;
- learn how tournaments are conducted and
- describe the intramural and extramural.

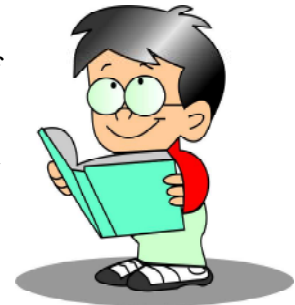

**16.1 MEANING AND DEFINITIONS OF TOURNAMENT**

A tournament is a series of games or matches that are used to decide the winner of a competition. In sports, a tournament is often used at the conclusion of the season to crown the league’s champion. Tournaments are usually conducted over a short time period. In addition to sporting events, tournaments are often staged for card games like poker, rummy and bridge. The tournament format indicates the matchups and the criteria for advancement and elimination.



**DO YOU KNOW?**

According to “John Cannon’s Dictionary of British History,” tournaments began as military competitions. The first tournament were equestrian and military competitions that were held in Europe at around the year 1000.

**“A competition for teams or single players in which a series of games is played, and the winners of each game play against each other until only one winner is left”**

**“A competition involving many competitors in a single sport or game is Called Tournament”**

**Participation in a tournament proves player’s capabilities.**

- Tournament provides an opportunity to demonstrate game skills.
- Tournaments is a powerful medium of popularize a particular game or sports.



- Tournaments are the greatest source of motivation for further effort and for life.
- Tournaments are a great medium to popularize a particular game and sports.
- Tournaments motivate the people towards the sports.
- Competitions\ and Tournaments provide a healthy entertainment of people.
- Tournaments help the players to monitor the level of their performance and evaluate their standards of achievement
- Participation in a tournament relieves the players.
- Tournament/competitions have become a big money spinner.



**Note**

**16.2 TYPES OF TOURNAMENT**

There are various types of tournaments. Some of the important tournament are listed below;



**Knock- out Tournaments-** In knock-out tournament a team continues to play further matches as per schedule till defeated.



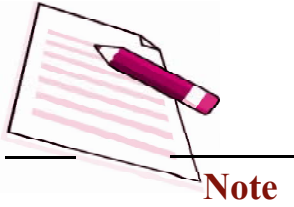

### KNOCK-OUT TOURNAMENT

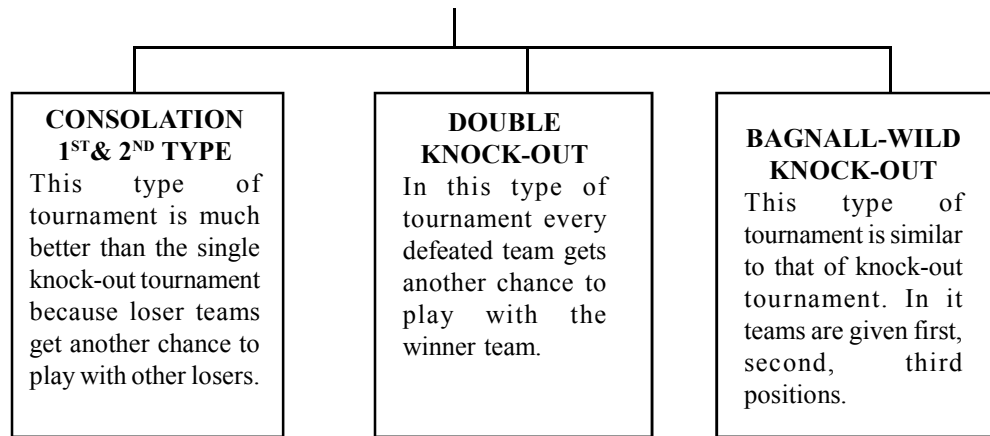

**League Tournaments-** In this system a team has to play match with all other participating teams hence the number of matches increase.

### LEAGUE OR ROUND ROBIN TOURNAMENT

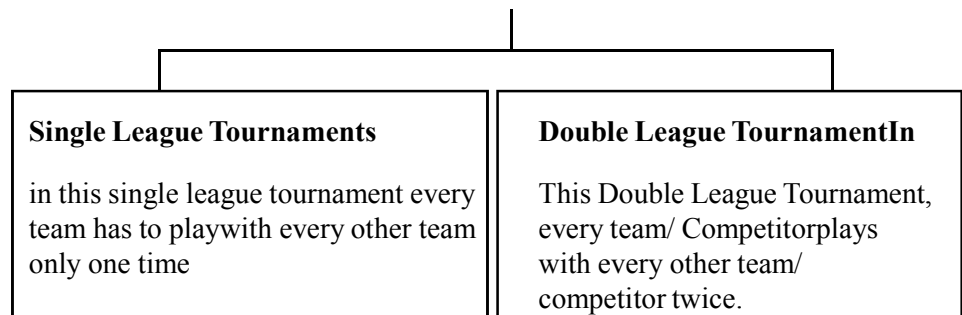

**Combination Tournament-** This type of tournament involves a combination of knock-out and the league system depending upon the suitability of the activity.

### COMBINATION TOURNAMENT

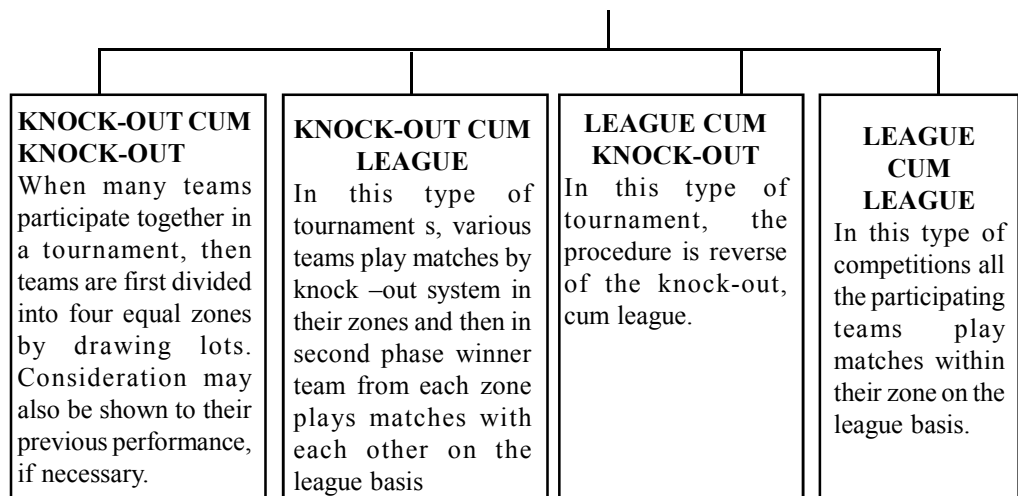

**Challenge Tournament-** In this method lower seeded players give challenge to higher seeded player. Thus challenge round goes till the last player. These types of tournament are usually organized for Wrestling, Table tennis, Badminton, Archery , Squash etc.

### CHALLENGE TOURNAMENT

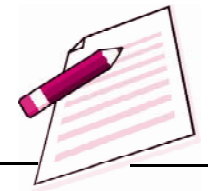
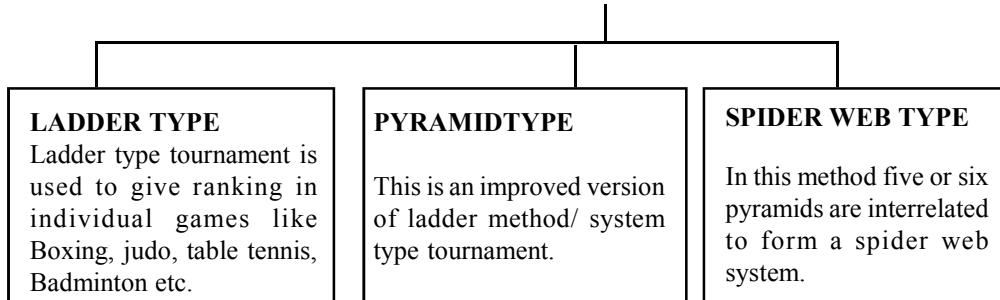

**Note**

Places	Players	Places
1	A	
2	B	
3	C	
4	D	
5	E	
Places		Places

Ladder Type

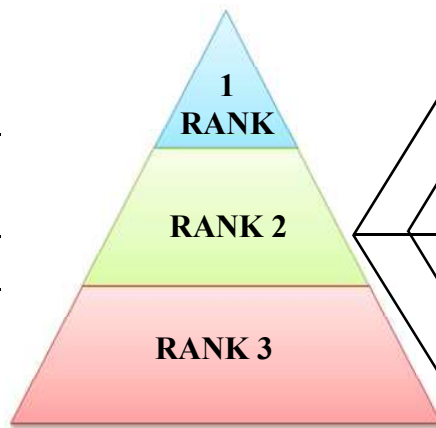

Pyramid Type

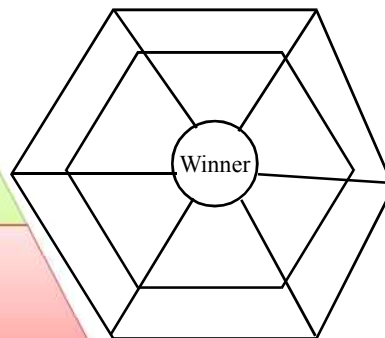

Spider webType



**DO YOU KNOW?**

RANK 3's player can challenge the player of rank 1 or rank 2. If he wins then the ranks of both the players will change among themselves.

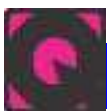

**INTEXT QUESTION 16.1**

1. Explain the meaning of tournament.

.....

.....



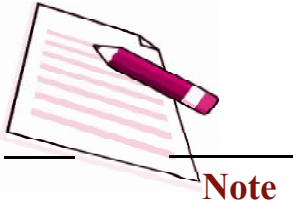

2. List down the types of tournament.  
.....
3. Explain the importance of tournament.  
.....
4. Explain round robin tournament.  
.....

**16.2.1 Procedure to Draw of Fixture**

**WE CAN SAY**  
 “Fixture is a planned process of a tournament to be played. Fixture may be defined as schedule of the teams taking part in the tournament and the methods of deciding the course of competition”.



Here we will discuss two types of main fixture procedure

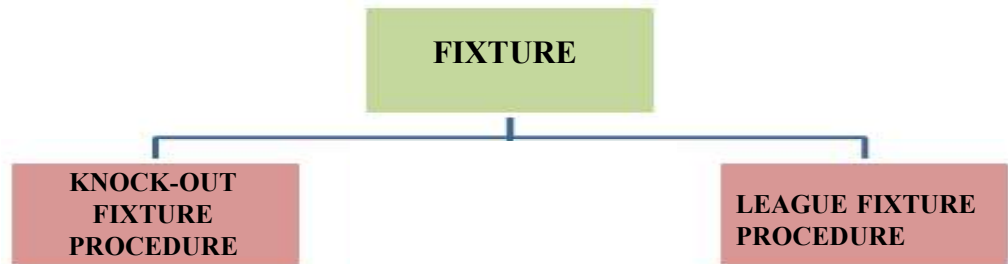

**Knock-out Fixture Procedure-** In this type of fixture a team will be eliminated immediately after defeat. It has less number of matches as compare to other types of fixture procedure, thus easy to conduct



**DO YOU KNOW?**

The success of the tournaments fully depends upon suitable fixture. Tournaments are played in various forms of fixture. Setting up the fixture means, making arrangement of competitions among teams.  
 “Fixture is a process of arranging the teams in systematic order in various groups for competitive fights for physical activity”



### 16.2.2 Procedure of Knock-out Fixture

First we have to determine the number of teams in upper half and lower half:

In case of even number of teams:

$$\text{Teams in upper half will be: } \frac{n}{2}$$

For 12 Teams

$$\text{Teams in upper half} = \frac{n}{2} = \frac{12}{2} = 6$$

Means, there will be 6 teams in upper half and 6 team in lower half

In case of odd number of teams:

$$\text{Teams in upper half will be: } \frac{n+1}{2}$$

$$\text{Teams in lower half will be: } \frac{n-1}{2}$$

For 13 Teams

$$\text{Teams in upper half} = \frac{n+1}{2} = \frac{13+1}{2} = \frac{14}{2} = 7$$

$$\text{Teams in lower half} = \frac{n-1}{2} = \frac{13-1}{2} = \frac{12}{2} = 6$$

Means, there will be 7 teams in upper half and 6 teams in lower half

**If number of teams are 2,4,8,16,32, ....then there is no need of 'bye'.**

i) Total Number of teams = 4

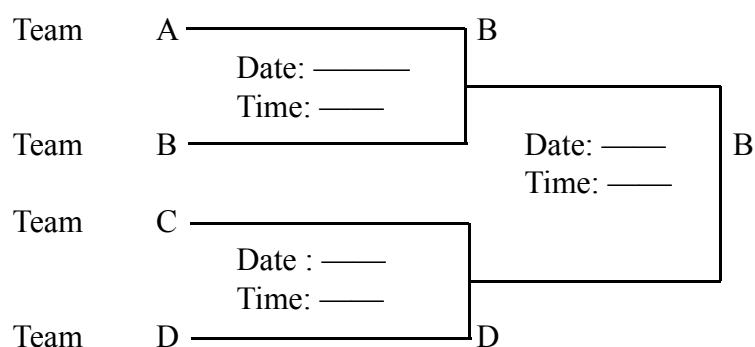

Exploration : Match between A Vs B won by B

Match between C Vs B won by D

Final match held between B Vs D won by B

Round I      Round II

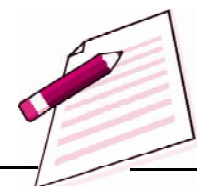

**Note**





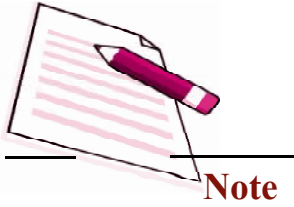

ii) Total Number of Team = 8

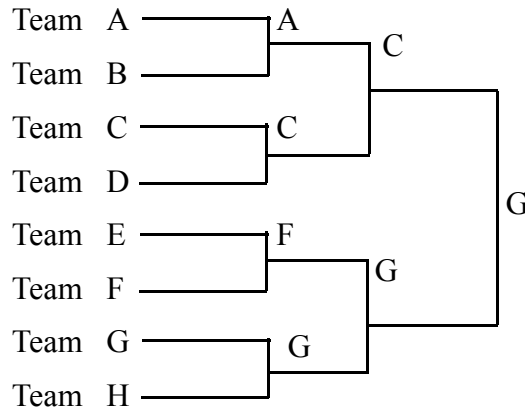

Explanation Match between A Vs B won by A in Round one  
 Match between C Vs D won by C in Round one  
 Match between E Vs F won by F in Round one  
 Match between G Vs H won by G in Round one  
 Match between A Vs C won by C in Round Two  
 Match between F Vs G won by G in Round Two  
 Final Match between C Vs G won by G in Finals

**Bye is advantage to a team to exempt to play first round, generally given by drawing lots system.**

If the number of teams are not the lower of 2 (Two) then we will follow different method.

we have to determine the “Byes”

Formula of bye: = Next power of two from total number of teams – total number of teams

**Example:**

Next power of two from total number of teams	total number of teams	Number of Byes
8	7	1
16	11	5
32	21	11

**Allotment of byes to teams**

First bye will be given to last team of lower half, Second bye will be given to first team of upper half. Third bye will be given to last team of first half and fourth bye will be given to first team of lower half. After that same pattern will be followed.





Total Number of team = 11 (Odd Number)

$$\text{Total Number of team in Upper half} = \frac{n+1}{2} = \frac{11+1}{2} = \frac{12}{2} = 6$$

Number of byes :  $16 - 11 = 5$

Teams  $R_1$   $R_2$   $R_3$  Finals

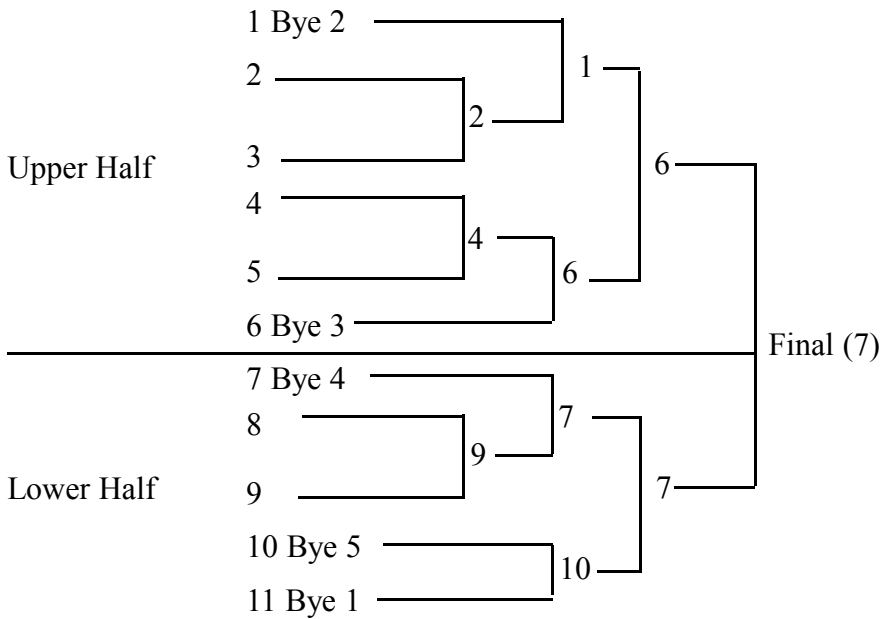

Total Number of Teams = 6 (Even Number)

$$\text{Number of teams in upper half} = \frac{n}{2} = \frac{6}{2} = 3$$

Number of byes :  $8 - 6 = 2$

Teams  $R_1$   $R_2$  Finals

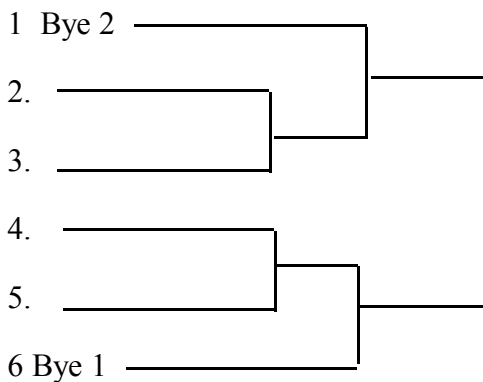

R = Round





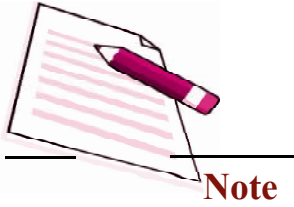

**Note**





**Advantage of knock-out Fixture Procedure**

 <p>Less Expensive</p>	 <p>Less Time needed</p>	 <p>Less tiredness to players</p>	 <p>number of organizers required</p>
---	---	---	--

**Disadvantage of Knock-out Fixture Procedure**

 <p>High Stress on Players</p>	 <p>Good Team May Eliminated</p>	 <p>Selection of Players is difficult</p>
---	---	--



**DO YOU KNOW?**

**“BYE”:** - A bye is a special privilege given to a team in the initial rounds because of which it gets exempted from playing in the first round and directly enters the second round.

**Seeding:** - Seeding is given to some special teams or those teams which are winner/runner up teams of the last year’s tournament.

**Special seeding:** - In this type if seeding the seeded players are brought straight away to quarter-finals or semi-finals.

**16.2.3 Single League or Round Robin**

In single League or Round robin fixture every team will play with every team of the tournament.

Formula to determine the number of matches (7 teams):

$$\text{Total number of matches} = n(n-1)/2 = 7(7-1)/2 = 7(6)/2 = 42/2 = 21 \text{ matches}$$



Ist Round	2nd Round	3rd Round	4th Round	5th Round	6th Round
A-B					
A-B	B-C				
A-B	B-D	C-D			
A-B	B-E	C-E	D-E		
A-B	B-F	C-F	D-F	E-F	
A-B	B-G	C-G	D-G	E-G	F-G

**League Fixture procedure:-** In this type of fixture each team plays with every other team at least once if it is single league fixture procedure tournament but in case of double league fixture procedure tournament, every team plays without consideration of winning or defeat in a match.

**League Fixture**

- Single Laegue
- Double Laegue

Fixture of 7 teams in Single League tournament where teams are represented by alphabets A to G. The number of matches are 21. For winning team is given 2 points, for loss no point and for draw 1 point is awarded. A Gerward final score is compared to decide winner of tournament.

**ACTIVITY 16.1**

Make a league fixture of 8 teams

**Advantage of league fixture Procedure**

  Selection of Skilled Players is very easy	 Strong Team Can Win	 Players Interest	 Overcome lacking
---	--	---	--



**Note**



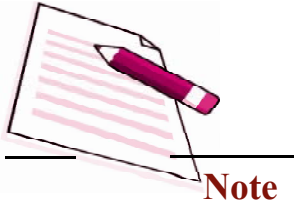

**Disadvantage of League Fixture Procedure**

 <p><b>Time Consuming</b></p>	 <p><b>Lot of Injuries</b></p>	 <p><b>Complicated scoring</b></p>	 <p><b>Less interest players and Spectators</b></p>
--	---	--	--

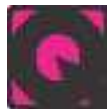

**INTEXT QUESTION 16.2**

1. Explain the advantage of knock-out fixture.  
.....
2. What is Seeding?  
.....
3. What is special seeding?  
.....

**16.3 HOW TO CONDUCT A TOURNAMENT**

**Pre-Tournament Preparation**

- A-After finalizing the event we also prepare a budget and finalizing the dates and venues.
- B-Arrangement of the equipment and playfields.
- C-To provide information of the tournament to the participating teams.
- D- Make the fixture and events rules and regulations.
- E-Accommodation arrangement for students & referees.
- F-Arrangement of trophies, Medal, Certificate etc.,
- G-Arrangement of transportations

**During - Tournament Preparation**

- A-Check all the equipment, ground facilities before starting the events.
- B-Check all players' eligibility of players and other officials.
- C-Provide first- aid to injured players.
- D-Prepare matches result, score sheet or press release.
- E-Supervise and check smooth working officials & matches conducted on fixture bases.
- F-Provide refreshment, meals, transportation to officials and players.
- G-Check and maintain discipline among spectators.



**Post-Tournament Preparation**

- A-Check the departing teams, refund security money and other related documents.
- B-Present the Medal, Merit certificate, Trophy to the position holder’s players.
- C-Make the payments of officials and other bodies.
- D>Returns the borrowed things to the concerned ones.
- E-Make a final press release report.
- F-Make a final event report and present to authority.
- G- Distributing the certificate of participating team.



**Note**



**INTEXT QUESTIONS 16.3**

- 1) Fill in the Blanks
  - a) Ladder type tournament is type of .....
  - b) Knock out – cum league tournament is the type of.....
  - c) Double league tournament is the type of .....
  - d) Consolation 1<sup>st</sup> and 2<sup>nd</sup> type tournament is the type of .....

2) Match the following statement of column

1- Provide the opportunities to demonstrate game skill	A- These types of tournament are usually organized for Wrestling, Table Tennis, Badminton, Archery, Squash etc.
2- Combination tournaments	B- This type of tournament involves a combination of knock-out and the league system depending upon the suitability of the activity.
3- League cum knock-out tournaments	C- Importance of tournament.
4- Challenge tournaments	D- Type of tournaments



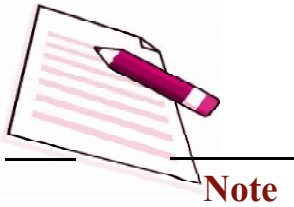

### 16.4 INTRAMURAL

The word “Intramural” is a combination of two Latin words “intra” and “murus”. Intra meaning is ‘within’ and Murus meaning is ‘wall’. Intramurals activities should form the basis of all programmes and competitions. All students should be provided opportunities to compete regardless of their skills. Intramurals received the major attention as part of physical education programme of a school. The intramurals programme may also be viewed from a different angle. Intramurals should be under the direction of the physical education department of a school; and participation of the student may be taken as taking part in general activities such as music, debate, dance, public speaking, and dramatics. Few of intramural level competitions like Inter-Class, Inter-House, and Inter-Hostel etc.



#### DO YOU KNOW?

“A game for each and each for a game” may be taken up as its motto.

#### Objectives of Intramural

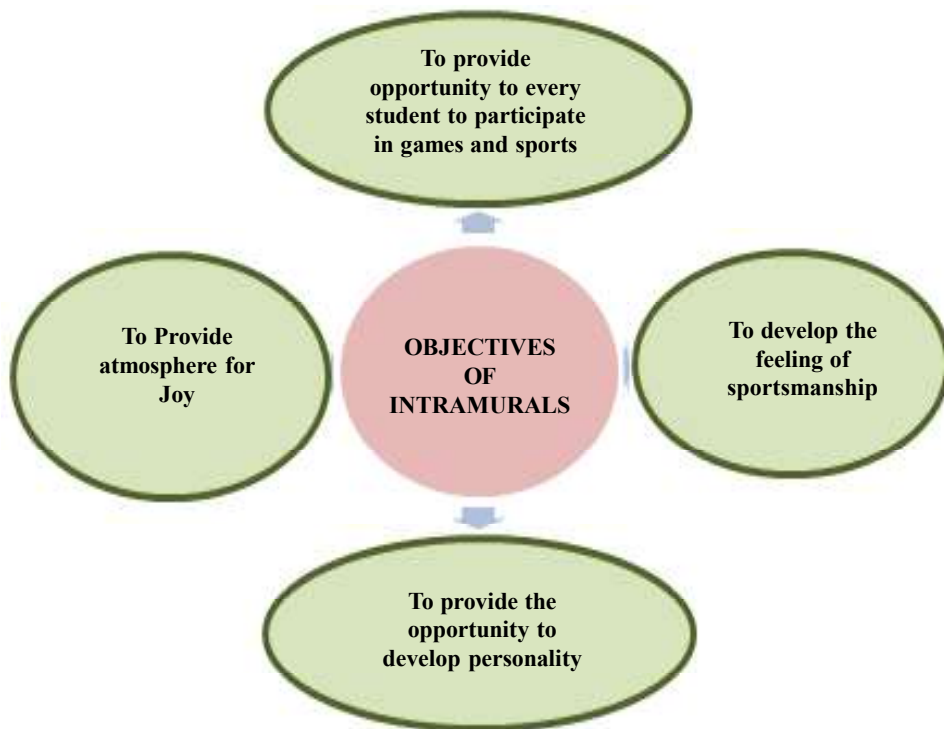

### Importance of Intramural

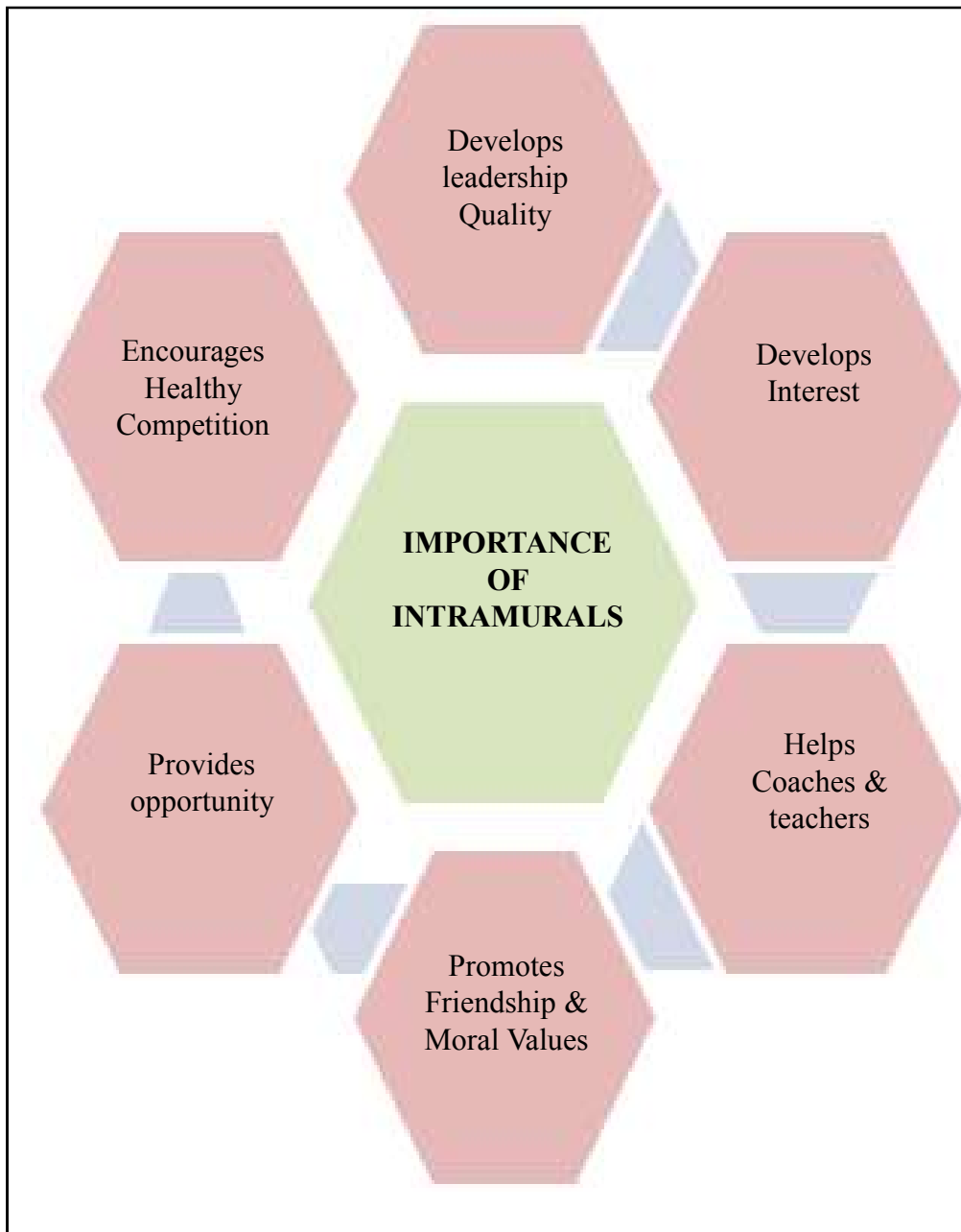

#### Note

#### 16.4.1 Extramural

Extramural sports would involve competitions with teams outside of your own institution or school”. Extramural competitions are to find the talented players and to give exposure to good player at upper level. Few of extramural competitions like Inter -school, Inter-college, Inter-District, State, and National and Inter-National level.





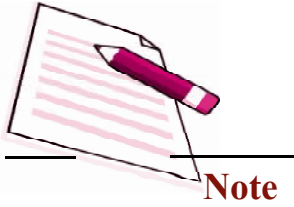

**DO YOU KNOW?**

The word “extramural” is also a Latin word “Extra” meaning “Outside” or “beyond” the wall.

**Objective of Extramural**

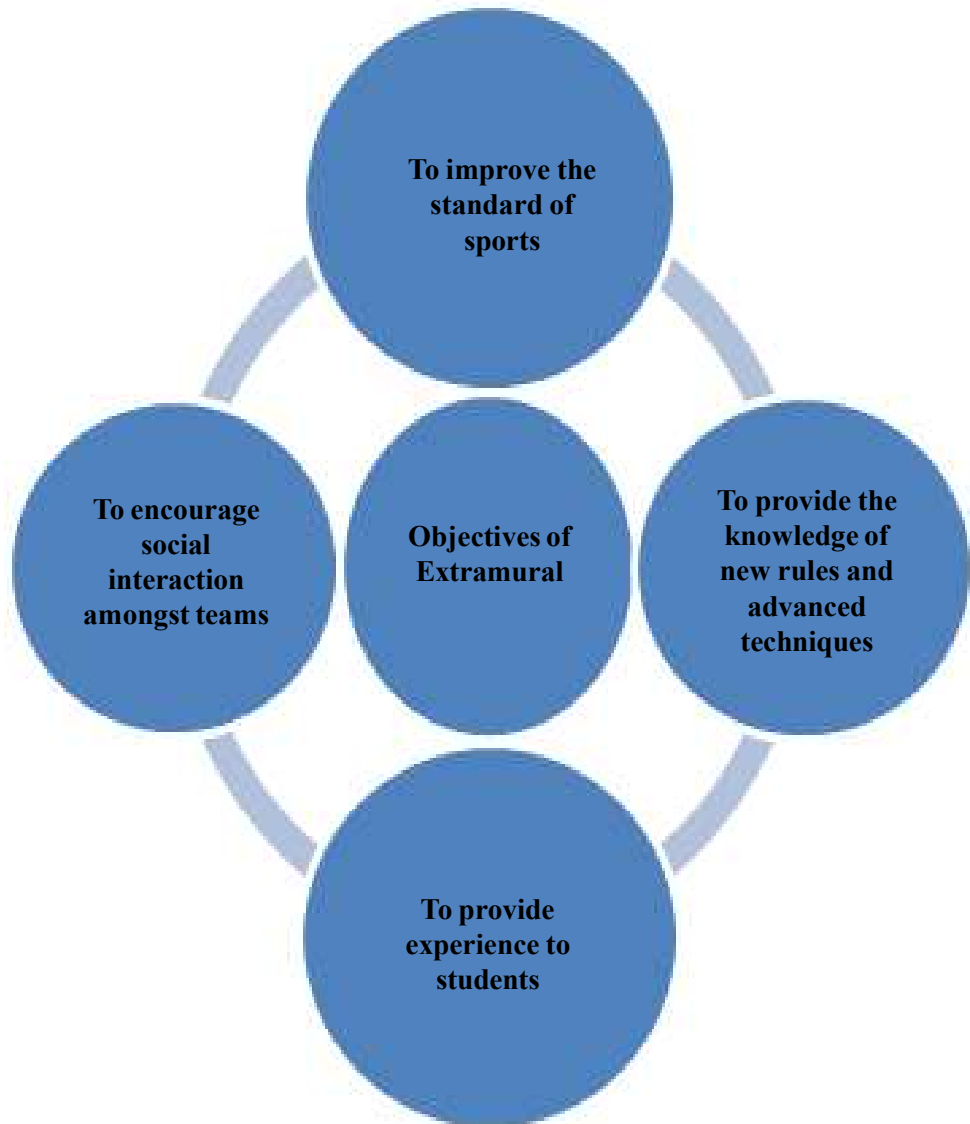

**Difference between Intramural and Extramural**

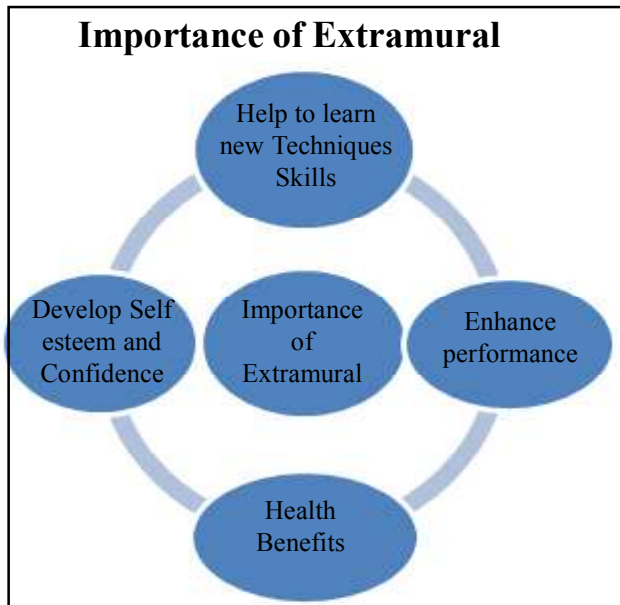

**Note**

<b>Intramural</b>	<b>Extramural</b>
<b>Intramural</b> competitions are organized by the school, college, Institute within the campus of the institute, college, school.	<b>Extramural</b> competition are not organized by the school/ college/ institute/associations, amongst school/ institution/ college
<b>Intramural</b> competition is very easy to manage.	<b>Extramural</b> is tough to manage as compared to intramural.
<b>Intramural</b> no students of other school can participate in this activity.	<b>Extramural</b> competition the students of other school also participate in competition. It is also inter - school competition.
<b>Intramural</b> competitions large number of students are know each to other.	<b>Extramural</b> competitionmostof the students are not know to each other.

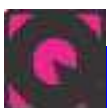

**INTEXT QUESTION 16.4**

1. Define intramurals.

.....



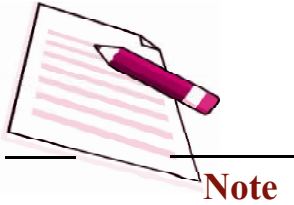

2. Define extramural.

.....

**Fill in the Blanks**

3. i) Inter-District tournament is type of .....
- ii) Inter class tournament is the type of .....
- iii) Intramural competition develops ..... quality.

**4. Match the statements of column 'A' with the statements of column 'B' in a meaningful way.**

- |  |  |
|--|--|
| 1) Intramural Competition  | A) Most of the students are not known to each other. |
| 2) Extramural Competition  | B) Very easy to conduct                              |
| 3) To encourage social interaction among the teams               | C) Intramural Competition                            |
| 4) Competition needs less time and funds to organize competition | D) Objective of Extramural Competition               |



**WHAT YOU HAVE LEARNT**

- There are four types of tournament like knockout tournament, league or round robin tournament, combination and challenge tournament.
- How to organize tournament and steps of organizing tournament.
- Intramural activity is organized in school between classes or houses
- Extramural activity is organized between different-different schools/ institution
- Fixture is a planned process of a tournament to be played
- Types of fixture, knockout, league or ladder and advantage or disadvantage of all types of fixture.



**TERMINAL QUESTIONS**

1. Make a knock –out fixture of 13 teams.
2. Make a league fixture of 12 teams.
3. What do you mean by tournament? Explain the importance and types of tournament.



4. What is intramural tournament? Describe how to conduct a sports event in a school.
5. Explain the various types of fixture and describe the duties of various committees in the sports event.



### ANSWER TO INTEXT QUESTION

#### 16.1

1. Tournament is a series of games or matches that are used to decide the winner of a competition.
2.
  - i) Knock out tournament
  - ii) League tournament,
  - iii) Challenge tournament,
  - iv) Combination Tournament.
3.
  - i) Tournament provides an opportunity to demonstrate games skill,
  - ii) Tournament motivate the people towards sports
- 4) In league or round robin tournament system a team has to play match with all the other participating team, hence the number of matches increase.

#### 16.2

1. Advantage of knockout fixture:-
  1. Less expensive
  2. Less time needed
  3. Less tiredness to players
  4. Less number of organizers required
- 2) Seeding: seeding is given to some special teams or players those teams/ players which were winner/ runner- up of the last year tournament.
- 3) Special Seeding: special seeding means the seeding players are brought straight away to quarter final.



#### Note



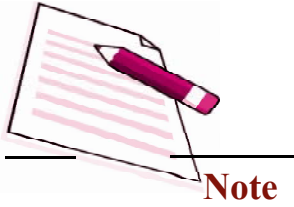

**16.3**

1. Fill in the blanks
  - a. Challenge Tournament,
  - b. Combination Tournament,
  - c. League Tournament,
  - d. Knock-out Tournament.
  
2. Match the following –
  1. C
  2. D
  3. B
  4. A

**16.4**

1. The word “Intramural” is a combination of two Latin words “intra” and “murus”. Intra meaning is ‘within’ and Murus meaning is ‘wall’. Intramurals activities should form the basis of all programmes and competitions.
2. Extramural sports would involve competitions with teams outside of your own institution or school”.
3. (i) Extramural (ii) Intramural (iii) Leadership
4. 1(B) 2(A) 3(D) 4(C)

